



In The Name of GOD



# IYNT 2016

## Iran-Shiraz



International Young Naturalist's Tournament





#problem number 13

Fire lighting

Reporter :

Pariya Nazari Nezhad giashi

Maple group



**Theories**

**Introducing  
different ways**

**Explaining studied  
ways**

**Conclusions**



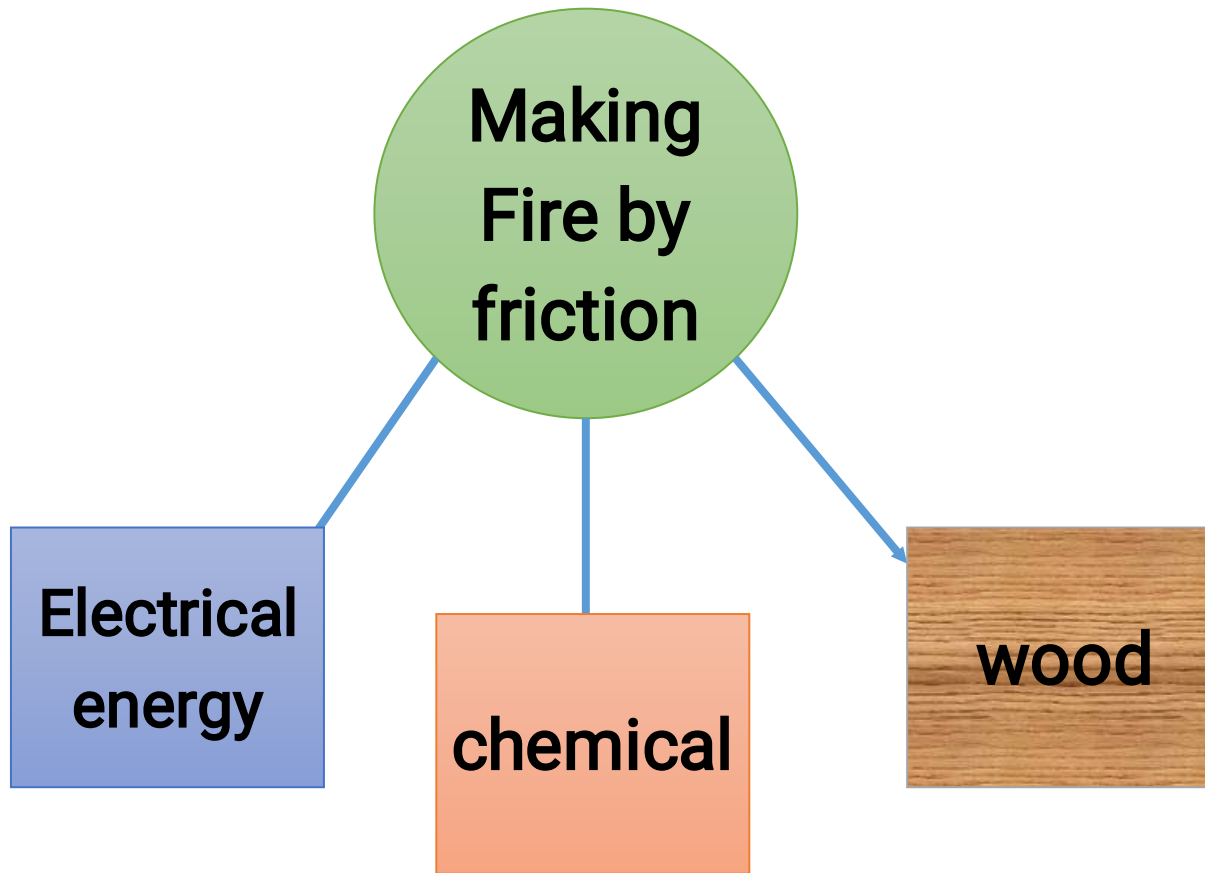

# wood

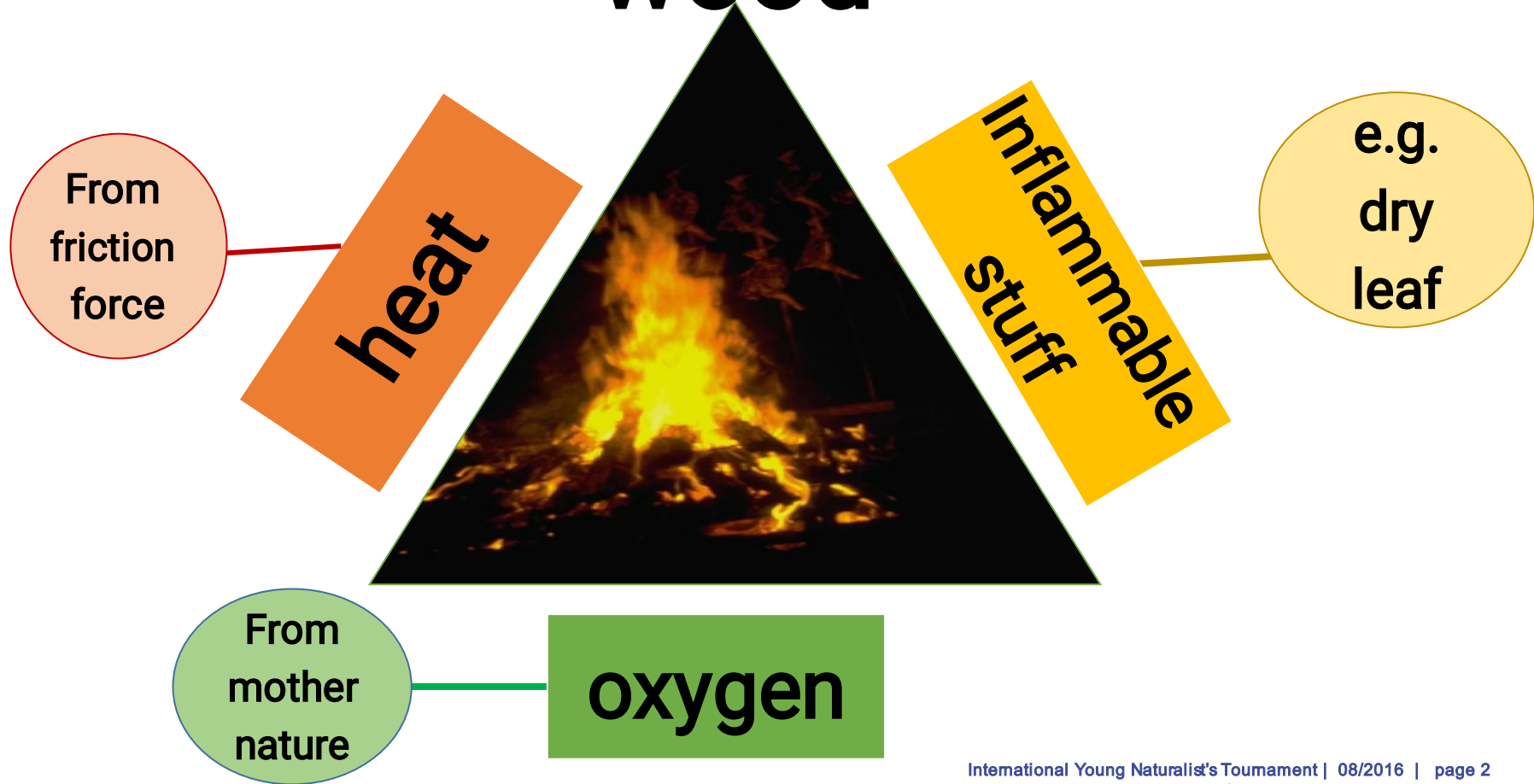

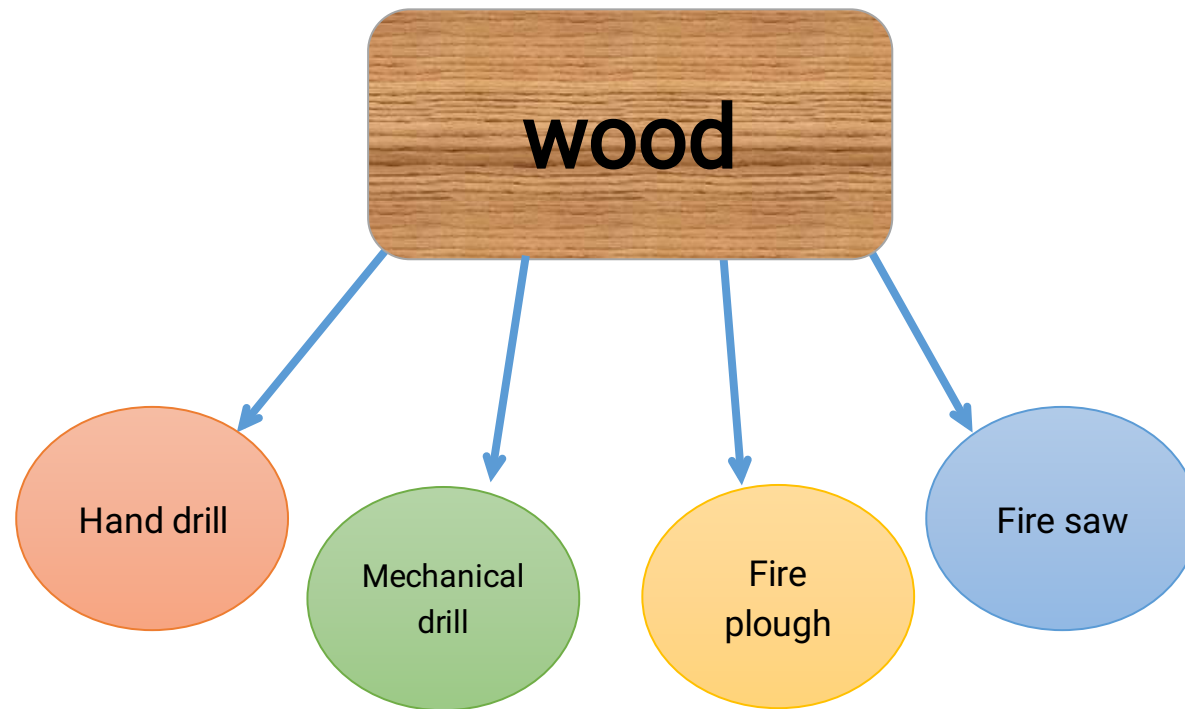



# Hand Drill

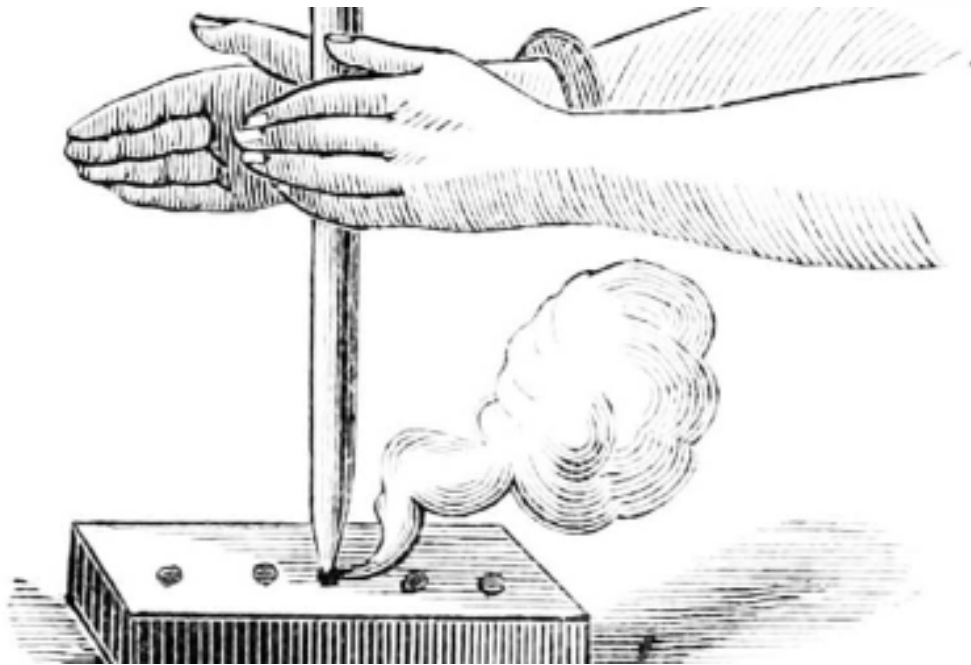

# Mechanical Drill

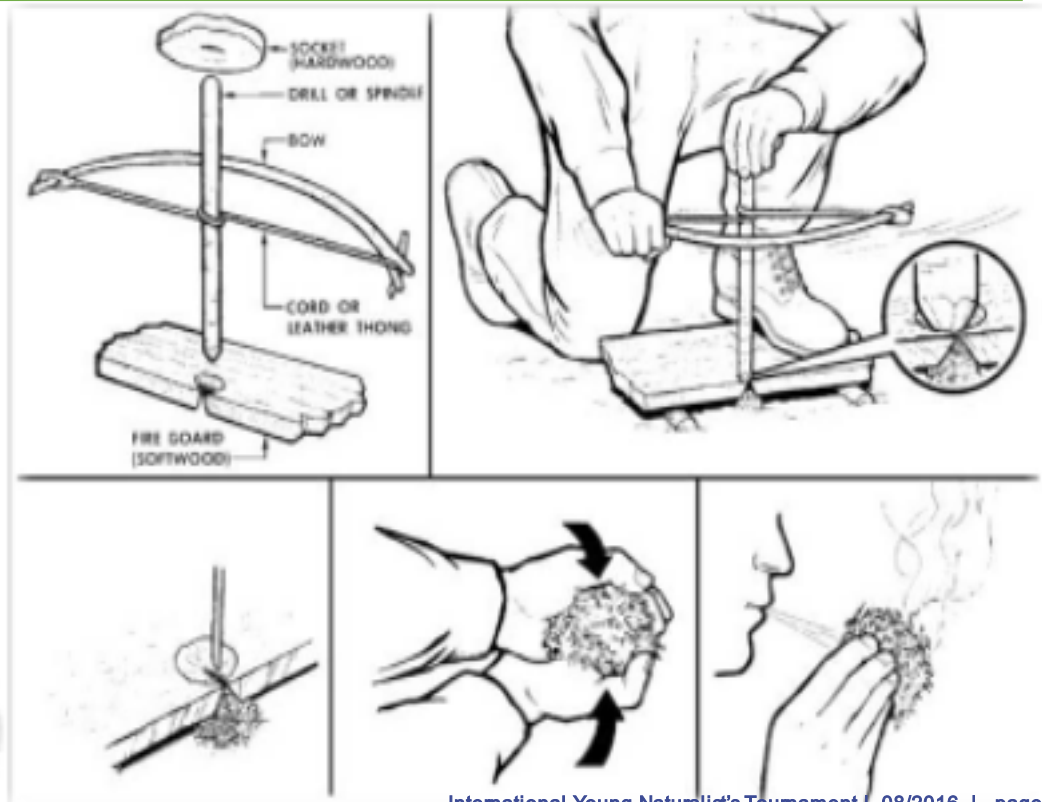
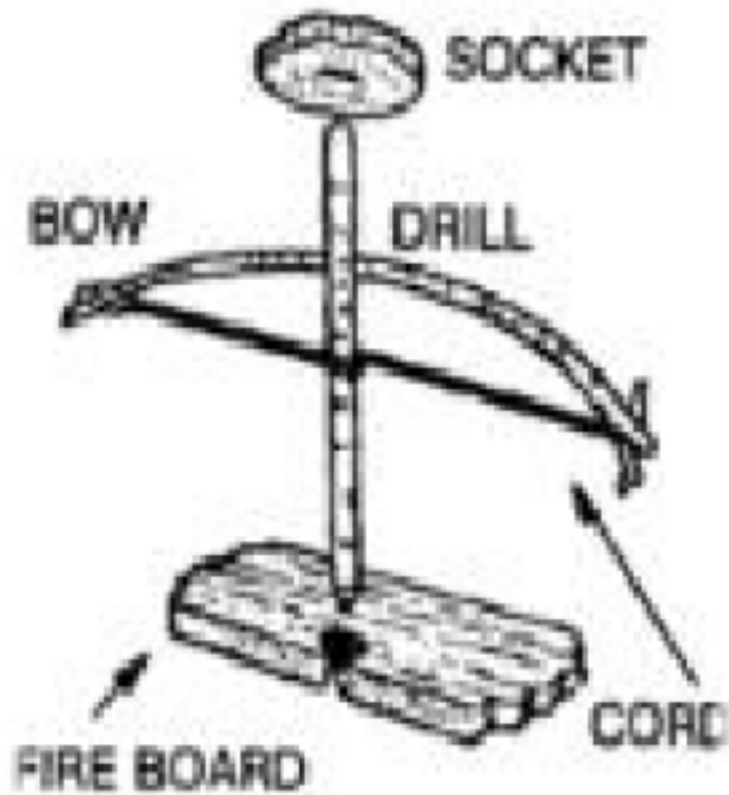

# Fire Plough

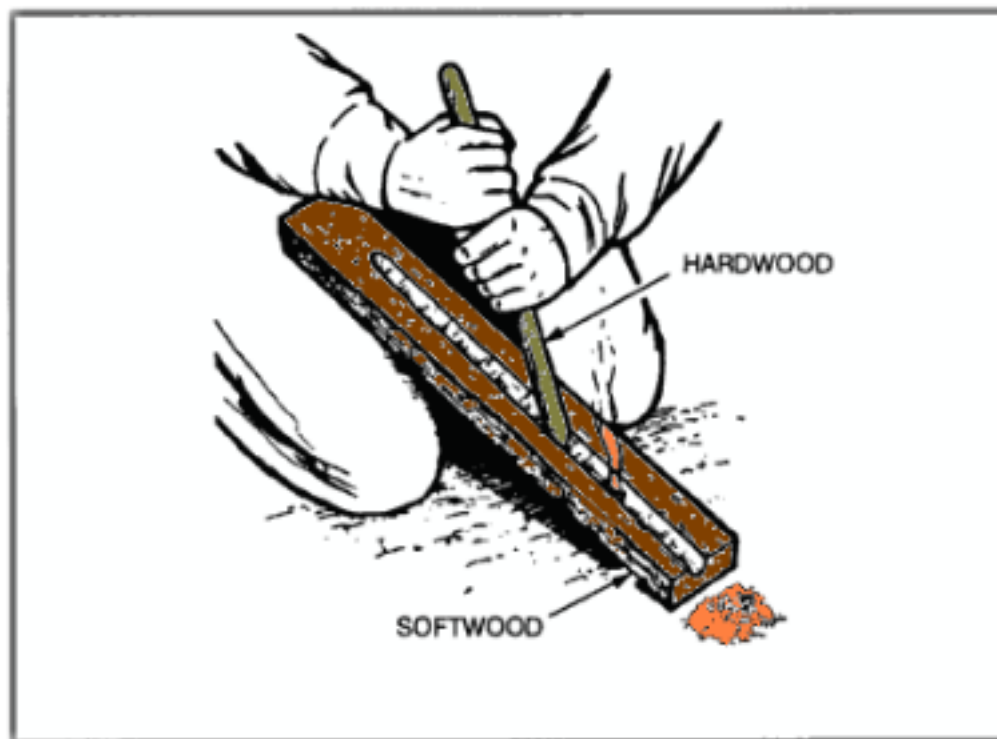

# Fire Saw



*Chemical:*  
*Potassium permanganate & Sugar*



# Electrical Energy: Steel wool & Battery

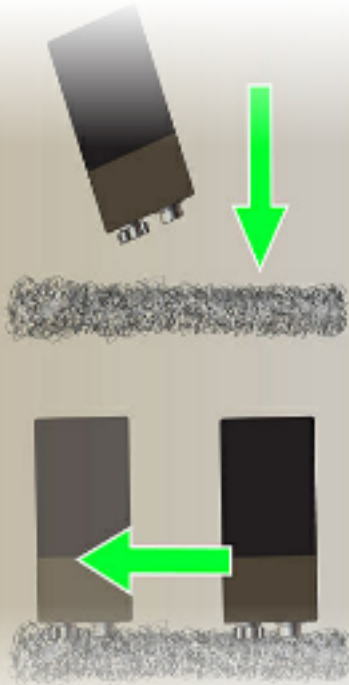

# Flint & Steel



# References:

1. Cache Lake Country by John J. Rowlands, published by the countryman press.
2. Making fire using the hand drill method by Jonathan Ridgeon.
3. Aboriginal Fire-Making, by Walter Hough, Published by: Wiley on behalf of the American Anthropological Association
4. our own experiments.



